

OPERATOR'S MANUAL

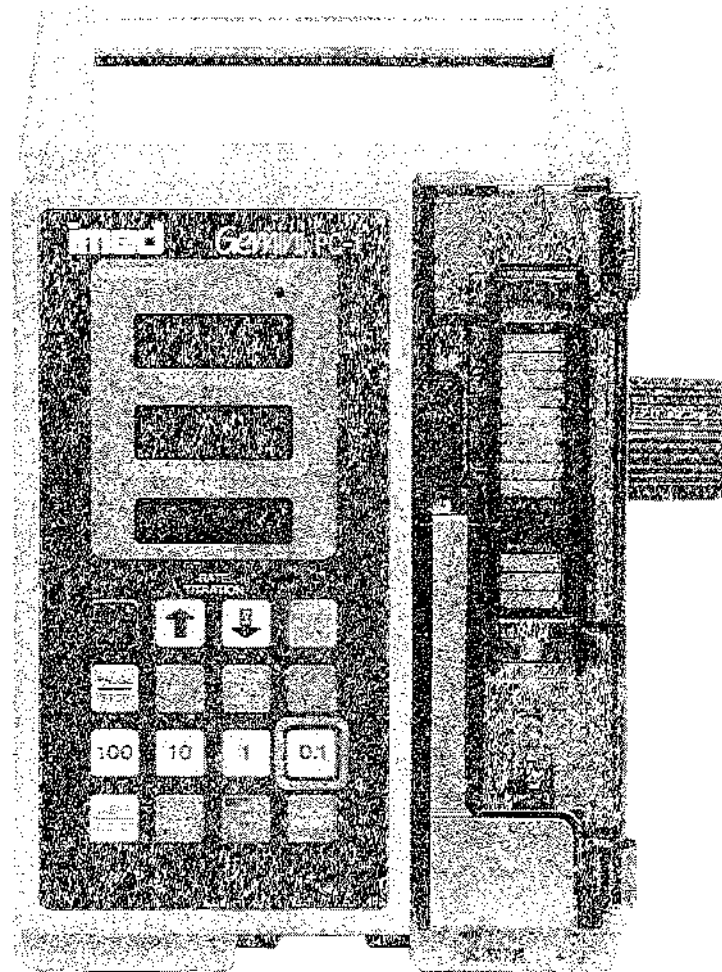

Gemini PC-1® v7.11

VOLUMETRIC INFUSION PUMP/CONTROLLER

RATE TITRATION/VERSATAPER®/AUTOTAPER™

WARNING AND CAUTION NOTICES:

USE ONLY HOSPITAL GRADE PLUG TO INSURE PROPER GROUNDING.
GROUNDING RELIABILITY CAN ONLY BE ACHIEVED BY CONNECTION TO A
RECEPTACLE MARKED "HOSPITAL GRADE".

DANGER: EXPLOSION HAZARD, DO NOT USE IN THE PRESENCE OF
FLAMMABLE ANESTHETICS.

DANGER: RISQUE D'EXPLOSION, NE PAS EMPLOYER EN PRESENCE
D'ANESTHESIQUES INFLAMMABLES.

WARNING: TO PREVENT UNRESTRICTED FLOW, CLOSE ROLLER CLAMP WHEN
FLO-STOP® IS OPEN.



CAUTION: ELECTRIC SHOCK HAZARD, DO NOT
REMOVE COVER OR BACK. REFER SERVICING TO
QUALIFIED SERVICE PERSONNEL.



CAUTION: REFER TO MANUAL.



WARNING: REPLACE FUSE AS MARKED.

WARNING

**IF THE PC-1 IS DROPPED AT ANY TIME, HAVE THE INSTRUMENT CHECKED BY
THE BIOMEDICAL DEPARTMENT PRIOR TO FURTHER USE.**

CAUTION: THE SELECTION, TESTING, AND USE OF HOST COMPUTER
HARDWARE AND SOFTWARE, IN CONJUNCTION WITH THE PC-1 IS STRICTLY
THE RESPONSIBILITY OF THE PURCHASER.

P/N 1310-9237-7, Verif. 01
Revision 1 August 1994
(Software V7.11)

Copyright 1994 by IMED® Corporation
9775 Businesspark Avenue
San Diego, CA 92131-1699 USA
(619) 566-9000

All Rights Reserved
Printed in USA
U.S. Patents 4,617,014; 4,689,043;
4,690,673; 4,725,205; 4,728,265;
Other Patents Pending

CONTENTS

| | |
|----|--|
| 1 | INTRODUCTION |
| 4 | INSTALLATION PROCEDURES |
| 5 | OPERATING MODES: "P/C MODE", "MACRO", "MICRO", "VersaTaper [®] ", "AutoTaper [™] " "10 psi", "SETUP" and "DIAGNOSTICS" |
| 6 | OPERATING FEATURES |
| 7 | FRONT PANEL CONTROLS AND INDICATORS |
| 8 | DESCRIPTION OF CONTROLS AND INDICATORS |
| 10 | ABBREVIATED SETUP AND OPERATING PROCEDURES |
| 13 | INDEPENDENT SETUP AND OPERATING PROCEDURES |
| 13 | Introduction |
| 13 | To Set Up a Primary Infusion |
| 15 | To Pause an Infusion |
| 15 | To Change Rate or VTBI During Infusion |
| 15 | To Titrate Rate |
| 16 | To Change Delivery Mode During Infusion (P/C Mode control unlocked) |
| 16 | To Restart an Infusion Following an "INFUSION COMPLETE-KVO" or an "EMPTY CONTAINER-KVO" Advisory |
| 16 | To View Total Volume Infused |
| 16 | To View Secondary Volume Infused While in Secondary |
| 16 | To Clear Total Volume Infused |
| 17 | To Set Up a Secondary (Piggyback) Infusion With Dual Rates |
| 18 | To View or Change Primary Infusion Parameters During a Secondary Infusion |
| 18 | To Stop a Secondary Infusion and Return to the Primary Infusion |
| 19 | To Infuse Using an Empty Container Detector (ECD) |
| 19 | To Enter the VersaTaper or AutoTaper Mode |
| 20 | To Set Up a VersaTaper Infusion |
| 20 | To Operate a VersaTaper Infusion |
| 21 | To Stop a VersaTaper Infusion |
| 21 | To Resume a VersaTaper Infusion |
| 22 | To Select AutoTaper Ramp Time |
| 22 | To Set Up an AutoTaper Infusion |
| 23 | To Operate an AutoTaper Infusion |
| 23 | To Stop an AutoTaper Infusion |
| 23 | To Resume an AutoTaper Infusion |
| 24 | To Enable an AutoTaper Patient Infusion |
| 24 | To Set Up and Operate an AutoTaper Patient Infusion |
| 25 | To Stop an AutoTaper Patient Infusion |
| 25 | To Resume an AutoTaper Patient Infusion |
| 26 | To Exit the VersaTaper/AutoTaper Mode |
| 26 | To Clear Alarms |
| 26 | To Power Off the PC-1 |
| 27 | MONITOR OR COMPUTER CONTROL SETUP AND OPERATING PROCEDURES |
| 27 | Introduction |
| 27 | To Establish PC-1/Host Computer Interface |
| 28 | To Set Up a Primary Infusion |
| 30 | To Power Off the PC-1 in MONITOR Operation |
| 31 | To Power Off the PC-1 in COMPUTER Operation |
| 32 | OPERATOR INFORMATION DISPLAY AND ALARM RESPONSE PROCEDURES |
| 39 | ADMINISTRATION SETS/ACCESSORIES |
| 40 | SPECIFICATIONS |
| 42 | CLEANING |
| | WARRANTY |
| | IMED SERVICE CENTER LOCATIONS |

NOTES

INTRODUCTION

The IMED GEMINI PC-1 is a single channel volumetric infusion pump and controller which provides accurate and automatic infusion of intravenous drugs and fluids. The PC-1 may be operated as either a pump or a controller, or it may be configured as only one or the other using a lockout feature. Secondary (or piggyback) fluid may also be automatically infused at delivery rates and volumes independent of the primary infusion parameters, with automatic changeover to the primary infusion parameters when the secondary infusion is complete and when using an ADD-i-MED® administration set.



Computer operation is provided when the PC-1 is interfaced with a host computer. The technical data necessary to interface the PC-1 with a host computer is provided in the C-2 Programming Guide.

The PC-1 can be set to run in three different operating conditions:

- INDEPENDENT Operation - the PC-1 operates as a stand-alone instrument, with no computer interface.
- MONITOR Operation - the PC-1 controls the infusion and a host computer monitors instrument operation.
- COMPUTER CONTROL Operation - the PC-1 is under the control of a host computer, which sets the infusion parameters and monitors PC-1 operation.

To enhance safety and ease of operation, the PC-1 provides operator prompts and advisories, a full range of alarms and malfunction visual and audio alerts. Also provided is a tamper-resistant option that enables the user to lockout the front panel controls once infusion parameters have been entered and the infusion has been started.

The GEMINI PC-1 utilizes peristaltic action in both the pump and controller modes. When the PC-1 is operated in the controller mode, it senses the pressure created by the height of the fluid container and uses that pressure as the occlusion pressure limit. In the pump mode, the occlusion pressure limit is preset at approximately 10 (± 2) psi for rates above 30 mL/hr. For rates 30 mL/hr and below, the occlusion pressure is rate-dependent to ensure rapid response to occlusions. The PC-1 may be locked into a rate-independent pump mode occlusion pressure of 10 (± 2) psi, if desired. However, this will result in significantly increased time to occlusion at rates below 30 mL/hr.

The infusion rate is selectable from 0.1 mL/hr to 999 mL/hr, and the volume to be infused (VTBI) from 0.1 mL to 9999 mL. The Rate Titration feature allows the selected channel's rate to be increased or decreased 1 mL/hr (MACRO mode) or 0.1 mL/hr (MICRO mode) with each single control press. Greater rate changes can be achieved by pressing and holding the   controls until the desired rate is attained. Rates between 0.1 and 99.9 mL/hr may be selected in tenths of a milliliter increments. VTBI's between 0.1 and 999.9 mL may be selected in tenths of a milliliter increments if the rate is also in tenths.

Using a lockout feature, the Biomedical Engineering Department can configure the PC-1 to be either an exclusively MICRO delivery instrument, or an exclusively MACRO delivery instrument:

MICRO

- rates from 0.1 to 99.9 mL/hr (in 0.1 mL/hr increments)
- VTBI's from 0.1 to 999.9 mL (in 0.1 mL increments)

MACRO

- rates from 1 to 999 mL/hr (in 1 mL/hr increments)
- VTBI's from 1 to 9999 mL (in 1 mL increments)

The PC-1 VersaTaper and AutoTaper modes provide manual and automated ramp up/taper down infusions for cyclic parenteral nutrition for both hospital and home care applications. Additionally, VersaTaper accommodates other sophisticated, multi-step infusions. A typical AutoTaper profile is depicted graphically below:

VERSATAPER:

- A VersaTaper infusion consists of up to 20 sequenced infusion steps
- Each infusion step is determined by entering a rate and VTBI parameter
- Once programmed, the instrument will repeat the VersaTaper infusion sequence each time that it is powered on and started
- If an infusion is prematurely discontinued, the user may elect to continue the infusion at the point of interruption or begin a new infusion at step 01.

AUTOTAPER:

- An AutoTaper infusion profile is derived from three inputs: ramp time, volume-to-be-infused (VTBI) and duration
- Ramp time is the percentage of the duration parameter that the instrument uses to ramp up to and down from the constant delivery rate
- Constant delivery rate is computed from the VTBI/Duration inputs
- The flow rate ramps up/down in 5 mL/hr increments when the constant delivery rate is ≥ 60 mL/hr and 1 mL/hr if the rate is < 60 mL/hr
- Once programmed, the instrument will repeat the AutoTaper infusion profile each time it is powered on and started
- If an infusion is prematurely discontinued prior to the beginning of the ramp down phase, the infusion may be resumed at the point of interruption or begin a new infusion.

AUTOTAPER: PATIENT:

- An AutoTaper: Patient mode infusion is identical to an AutoTaper mode infusion, except in its programming requirements. Ramp time is selected and the AutoTaper mode enabled initially. VTBI and duration are entered at the time of use.
- If an infusion is prematurely discontinued prior to the beginning of the ramp down phase, the infusion may be resumed at the point of interruption or begin a new infusion.

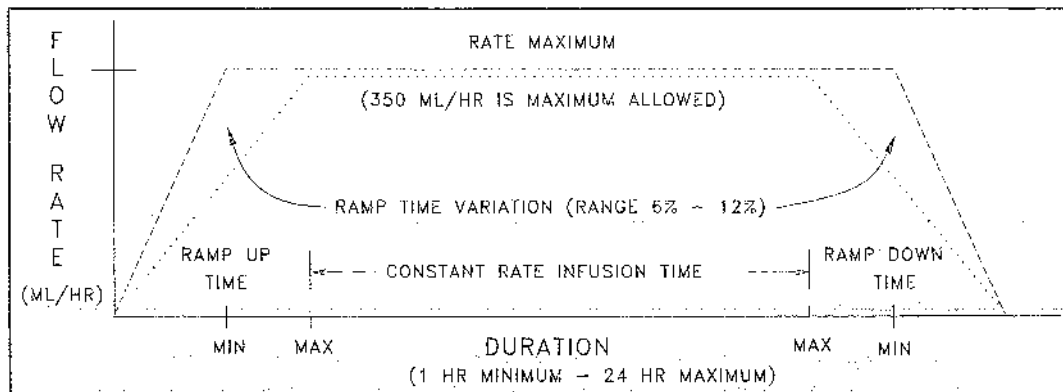

The PC-1 uses a wide variety of IMED GEMINI disposable administration sets. Primary sets are used for separate, independent primary infusions and for stand-alone gravity administration. Secondary infusions are possible using GEMINI ADD-i-MED sets and appropriate IMED SECONDARY sets. GEMINI disposable sets utilize a unique clamping device, the Flo-Stop to prevent inadvertent free-flow when a set is removed from the PC-1.

The PC-1 has been designed to interface with optional accessory equipment, including an empty container detector (ECD). When an ECD is attached to the drip chamber of the primary administration set, the PC-1 can infuse the entire contents of the fluid container.

NOTES

Although the PC-1 is built and tested to exacting specifications, it is not intended to replace the supervision of IV infusions by medical personnel. The user should become thoroughly familiar with the features and operations of the PC-1 and exercise vigilance in its utilization.

IMED has available a PC-1 Maintenance Manual which includes circuit diagrams, component parts lists and descriptions, calibration and test procedures, and other technical information to assist qualified service personnel in repair and maintenance of the instrument's repairable components.

INSTALLATION PROCEDURES

The PC-1 has been thoroughly inspected before shipment from the factory to insure its mechanical and electrical integrity. However, handling in transit may cause visible or hidden damage. Therefore, prior to initial use, the PC-1 should be inspected at the user's facility.

Remove the unit from the shipping container and inspect it carefully for damage. Check that the door operates freely. Check to ensure the urethane seal covering the pumping mechanism is not torn. Check the pole clamp for freedom of operation. Check the power cord for nicks and bent prongs on the connector. Check for any loose parts.

NOTE:

If the instrument shows evidence of damage in transit, notify carrier's agent immediately. Do not return damaged equipment to the factory before the carrier's agent has authorized repairs.

Contact IMED for authorization to return equipment for repair, whether damage or malfunction is the responsibility of the carrier, or of IMED.

Performance Check

Refer to the PC-1 Maintenance Manual, IMED P/N 1310-9027-00.

Battery Charge

The PC-1 is shipped with the battery in a charged condition. However, since a considerable time period could pass between shipment from the factory and initial use of the unit, perform a pre-operational battery charge. Connect the power cord to a 110 Volt receptacle. Allow the battery to charge for 8 hours. **Whenever possible, leave the power cord connected to the external power source while operating.**

RS-232 Connection/Computer Interface

Refer to the PC-1 Maintenance Manual, IMED P/N 1310-9027-00, and to the C2 Communications Protocol Programmer's Guide, IMED P/N 1320-9004-00.

**OPERATING MODES: "P/C MODE", "MACRO", "MICRO",
"VersaTaper®", "AutoTaper™", "10 psi", "SETUP" and
"DIAGNOSTIC"**

By utilizing the secondary functions of selected control keys during power up, the Biomedical Engineering Department may lock the PC-1 into specific operating modes. If the instrument has been locked into any specific configuration, the anticipated message prompting an infusion programming function will not scroll or a message(s) identifying the specific mode(s) invoked will scroll. Information regarding the scrolled messages can be found in the Operator Information Display and Alarm Response Procedures section of this manual.

NOTE

Prior to use, the user must determine whether the instrument configuration is appropriate for the prescribed infusion therapy.

For further information on these lock-out procedures, refer to the Biomedical Engineering Department, or to the PC-1 Maintenance Manual, IMED P/N 1310-9027-00.

OPERATING FEATURES

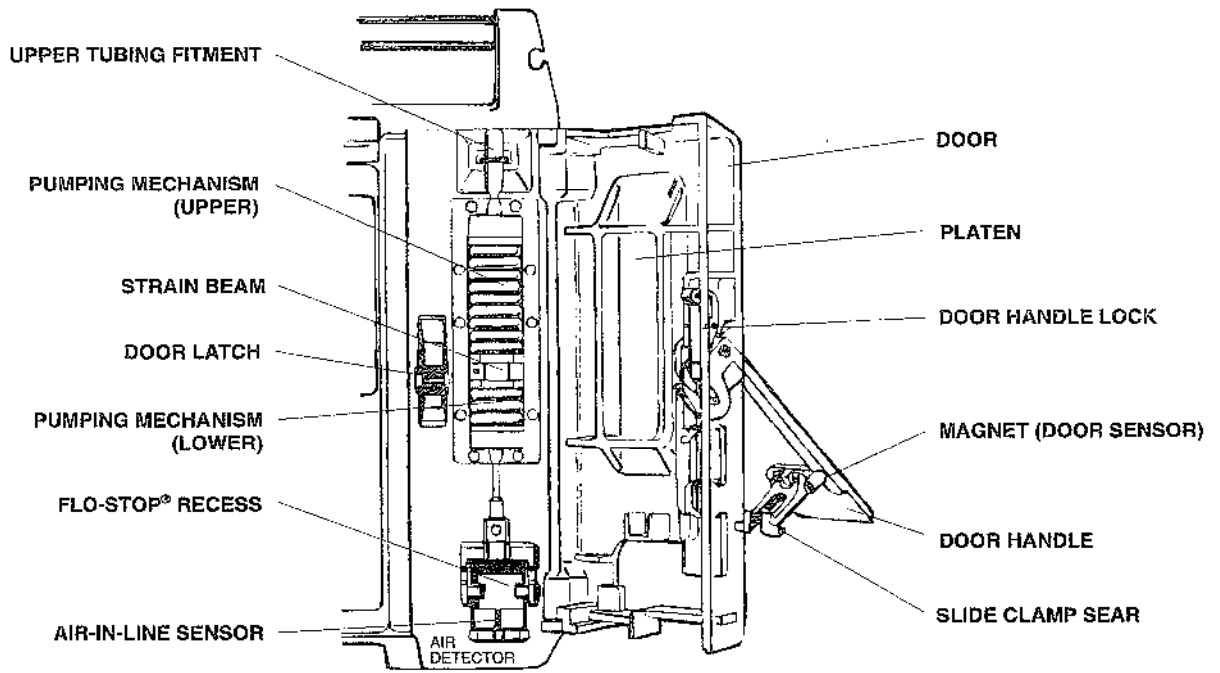

FRONT

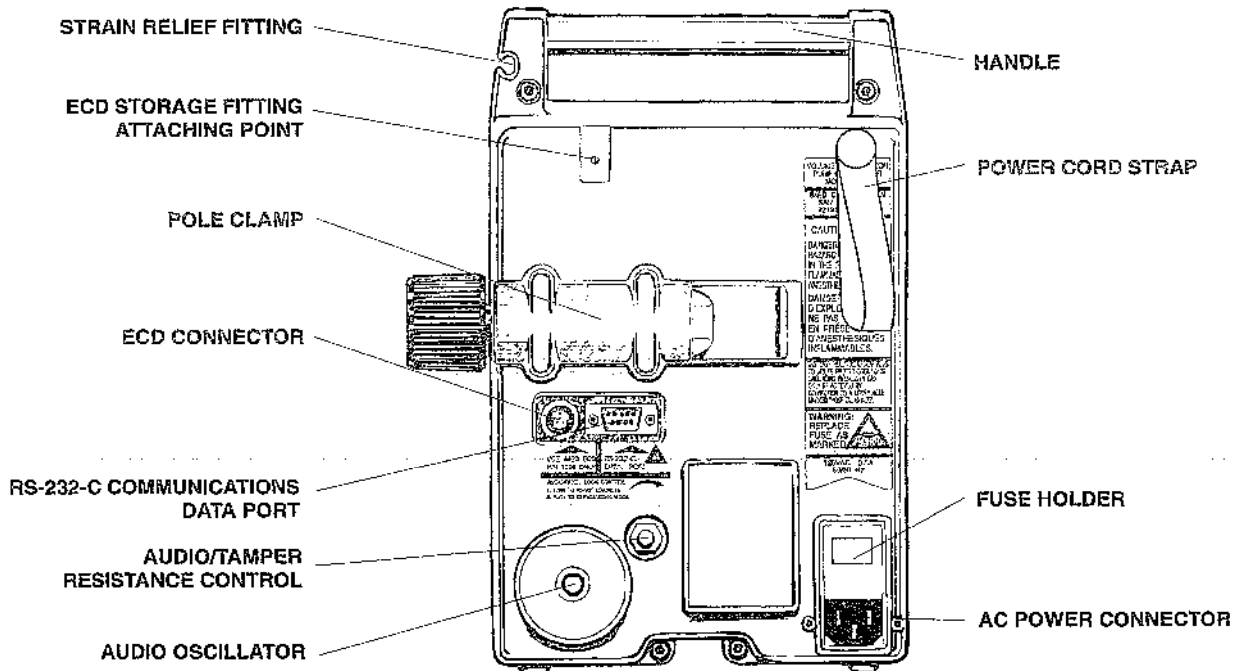

REAR

FRONT PANEL CONTROLS AND INDICATORS

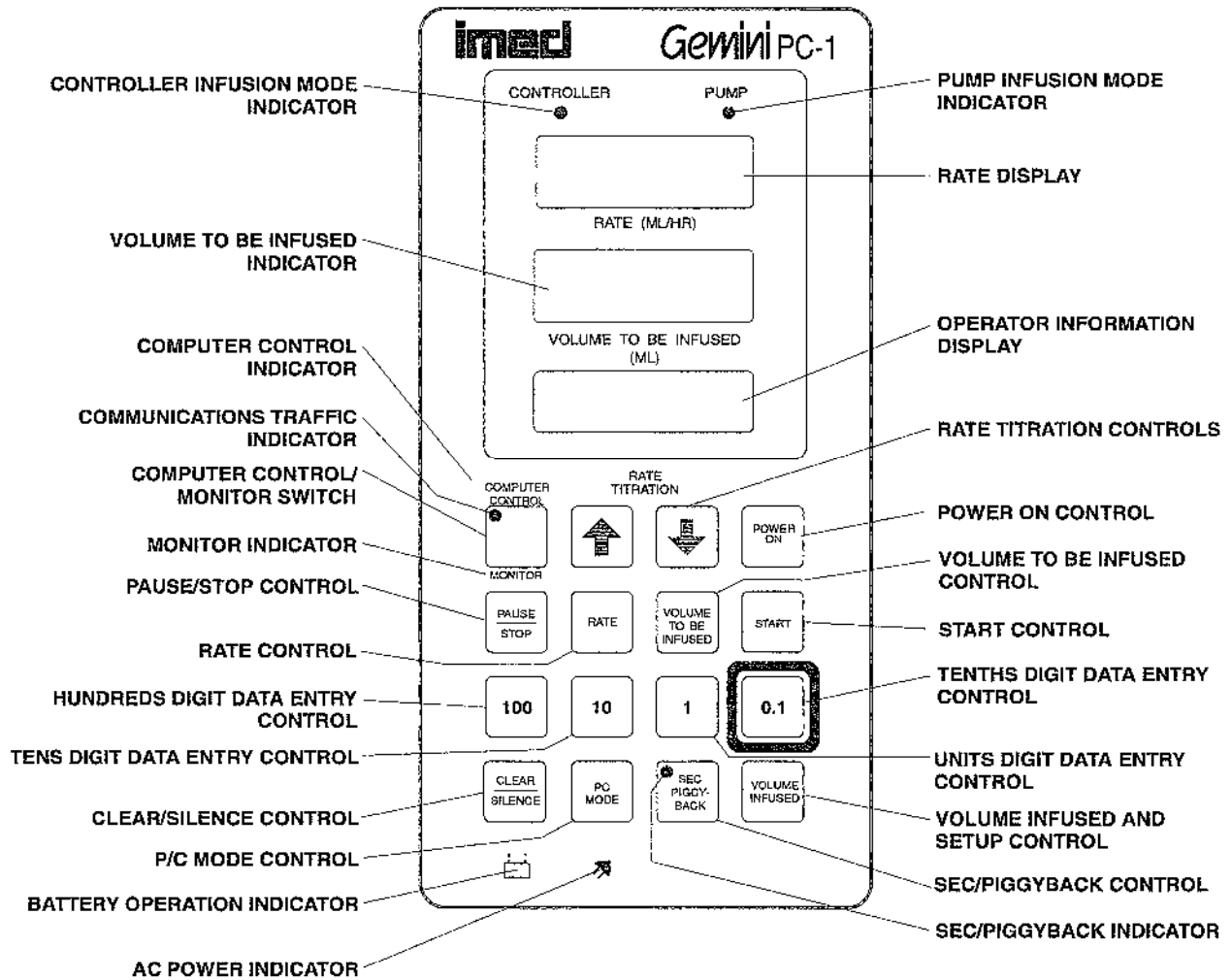

DESCRIPTION OF CONTROLS AND INDICATORS

COMPUTER CONTROL/MONITOR control - when pressed, selects either MONITOR or COMPUTER CONTROL when computer interface cable is connected; also used by the Biomedical Department to enter the maintenance mode.

Communications Traffic indicator - illuminates when communication traffic is flowing over the RS-232-C data communication link; operable only during Monitor and Computer Control operation.

COMPUTER CONTROL indicator - flashes when PC-1 computer control is allowed, prior to the first valid command; illuminates when control has occurred.

MONITOR indicator - illuminates when interface cable is connected, and when in MONITOR mode.

RATE TITRATION controls - when pressed, will increase or decrease the rate parameter 1 mL/hr (MACRO mode) or 0.1 mL/hr (MICRO mode) with each keypress or will scroll the rate up or down when pressed and held.

POWER ON control - when pressed, applies electrical power to the PC-1. If pressed during a hardware malfunction, silences audio alarm and turns off electrical power to all circuits.

PAUSE/STOP control - when pressed once, during a primary or secondary infusion, the infusion is stopped or (after 2 minutes, the "PRESS START" visual and audio prompt begins); when pressed a second time, the PC-1 is powered off.

RATE control - when pressed, allows the rate infusion parameter to be changed using the appropriate data entry controls.

VOLUME TO BE INFUSED (VTBI) control - when pressed, allows the VTBI parameter to be changed using the appropriate data entry controls. Also used during power up to enable the VersaTaper mode.

START control - when pressed, starts the infusion.

CLEAR/SILENCE data entry control - when pressed following a press of the RATE or VTBI control, clears the rate or VTBI parameter; when pressed following a press of the Volume Infused control, clears the total and secondary volume infused displays; when pressed during an alarm, advisory, or prompt, silences the audio for 2 minutes.

Hundreds & Thousands (100) Digit data entry control - when pressed, increments the hundreds digit of the rate infusion parameter (except when in MICRO delivery), or the hundreds and thousands digit of the VTBI infusion parameter (thousands not functional in MICRO delivery). Also used during power up to lock or unlock the MACRO mode.

Tens (10) Digit data entry control - when pressed, increments the tens digit of the rate or VTBI infusion parameter for the selected parameter.

Units (1) Digit data entry control - when pressed, increments the units digit of the rate or VTBI infusion parameter for the selected parameter.

DESCRIPTION OF CONTROLS AND INDICATORS (continued)

Tenths (0.1) Digit data entry control - when pressed, increments the tenths digit of the rate or VTBI infusion parameter for the selected parameter (not functional in MACRO delivery). Also used during power up to lock or unlock the MICRO mode.

P/C MODE control - when pressed with the P/C mode unlocked, alternately selects the PUMP delivery mode or the CONTROLLER delivery mode; also used to enable the START control to operate a VersaTaper infusion.

SEC/PIGGYBACK control - when pressed, selects the entry of secondary infusion parameters; if pressed during a secondary infusion, viewing and changing of the primary infusion parameters can occur.

Sec/Piggyback indicator - when flashing, indicates SEC/PIGGYBACK has been pressed; when illuminated, indicates a secondary infusion is in process.

VOLUME INFUSED control - when pressed once, will cause total volume infused to display, and enable total and secondary volume infused registers for clearing; a second press, while total volume infused is displaying, will cause the secondary volume infused to display and disable the clearing of total and secondary volume infused registers. Used by biomedical and other specifically trained personnel to access the SETUP mode to configure the instrument for specific operating modes. Also used during power up to enable the SETUP mode.

CONTROLLER and PUMP delivery mode indicator - when illuminated, indicates which delivery mode is selected; when flashing, indicates that the instrument is operating properly and that an infusion is in progress in that mode.

RATE display - displays primary and secondary rate infusion parameters, and other operator information.

VOLUME TO BE INFUSED (VTBI) display - displays primary and secondary VTBI infusion parameters, and other operator information; flashes volume infused values for six seconds following press of VOLUME INFUSED control.

Operator Information (Alarm/Status) display - displays various advisory, prompt, alarm, malfunction, and communication status information. (Refer to OPERATOR INFORMATION DISPLAY AND ALARM RESPONSE PROCEDURES section of this manual for specific response procedures.)

Battery Operation indicator - when flashing, indicates the PC-1 is operating on battery power.

AC Power Connected indicator - when illuminated, indicates the PC-1 is connected to an external power source.

AUDIO/TAMPER-RESISTANT control (on rear panel) - when rotated, varies the audio volume; when pressed and released, silences audio alarm for ≈2 minutes; when pressed and held for 3 seconds with the tamper-resistant feature enabled, will lock out all keypad controls except VOLUME INFUSED, SEC/PIGGYBACK and CLEAR/SILENCE; a repeat 3 second actuation will unlock the keypad controls.

ABBREVIATED SETUP AND OPERATING PROCEDURES

Introduction

The abbreviated procedures necessary to set up, start, and operate the PC-1 are described.

These procedures are provided for use by personnel already familiar with the setup and operation of the PC-1. Refer to the detailed procedures and alarm responses in the appropriate sections of this manual.

To Set Up a Primary Infusion

1. Connect PC-1 to external AC power source.
2. Press POWER ON.

WARNING

If the instrument alarms "HELP INTERNAL ERROR", DO NOT USE THE INSTRUMENT. Send it to the Biomedical Department for Inspection.

3. Prepare IV fluid container.
4. Open set package and close roller clamp.
5. Insert set spike into fluid container and hang container a minimum of 24 inches above the PC-1.
6. Fill drip chamber to fill line.
7. Open roller clamp and prime set to remove all air.
8. Close roller clamp.
9. Open door and install pumping chamber.
10. Close door.
11. Open roller clamp.
12. Attach set to patient's indwelling venipuncture device.
13. Press P/C MODE to change delivery mode, if not locked out.
14. Set rate and VTBI.
15. Press START.
16. Verify that the delivery mode indicator is flashing.

To Pause an Infusion

1. Press PAUSE/STOP once.
2. To resume infusion, press START.

To Stop an Infusion





1. Press PAUSE/STOP twice.

To Change Rate or VTBI During Infusion

1. To change rate, press RATE and use data entry controls.
2. To change VTBI, press VTBI and use data entry controls.
3. Press START.

ABBREVIATED SETUP AND OPERATING PROCEDURES (continued)

To Titrate Rate

1. Press  or  control once to increment or decrement the rate parameter 1 mL/hr (MACRO) or 0.1 mL/hr (MICRO); press and hold the  or  control to scroll the rate up or down to desired setting.
2. Press START to confirm and change to the new rate.

To Change Delivery Mode During Infusion (if not locked out).

1. Press P/C MODE.
2. Press START.

To Restart an Infusion Following an "INFUSION COMPLETE-KVO" or "EMPTY CONTAINER-KVO" Advisory

1. Press VTBI and reset volume to be infused using data entry controls.
2. Refill drip chamber if necessary.
3. Press RATE and change if necessary.
4. Press START.

To View Total Volume Infused

1. Press VOLUME INFUSED.

To View Secondary Volume Infused While in Secondary

1. Press VOLUME INFUSED twice.

To Clear Total Volume Infused and Secondary Volume Infused

1. Press VOLUME INFUSED.
2. Press CLEAR/SILENCE while display is flashing to clear both the total and secondary volume infused displays to "0" or "0.0".

NOTE

Volume Infused cannot be cleared while viewing Secondary Volume Infused.

To Set Up Secondary (Piggyback) Infusion With Dual Rates

1. Set up Primary infusion (using check valve set) as previously described.
2. Prepare Secondary container.
3. Open Secondary set package and close clamp.
4. Insert set spike into Secondary fluid container and hang container.
5. Attach Secondary set needle.
6. Fill drip chamber at least 2/3 full.
7. Open Secondary clamp and prime set. Close clamp.
8. Insert needle into upper injection site on Primary set.
9. Lower the Primary container using the hanger provided in the Secondary set package.
10. Press SEC/PIGGYBACK.
11. Press RATE and set Secondary rate using data entry controls.
12. Press VTBI and set Secondary volume to be infused using data entry controls.
13. Open the Secondary clamp.
14. Press START.

ABBREVIATED SETUP AND OPERATING PROCEDURES (continued)

To View or Change Primary Infusion Parameters During Secondary Infusion

1. Press SEC/PIGGYBACK and Primary parameters will display.
2. To change Primary rate, press RATE and use data entry controls during primary display.
3. To change Primary volume to be infused, press VTBI and use data entry controls during primary display.
4. Press SEC/PIGGYBACK.

To Stop a Secondary Infusion and Return to Primary Infusion

1. Press SEC/PIGGYBACK.
2. Press START during primary display.

To Infuse Using an ECD

1. Set up the Primary infusion.
2. Connect ECD.
3. Clear Primary VTBI to "0".
4. Press the units key once.
5. Press START.

To Use the VersaTaper Mode

1. Refer to the appropriate Independent Setup and Operating Procedures sections.

To Power Off The PC-1

1. Press PAUSE/STOP twice.

INDEPENDENT SETUP AND OPERATING PROCEDURES

Introduction

The detailed procedures necessary to set up and operate the PC-1 in the independent operating condition are described in the following section. Procedures for computer operation are described in the "MONITOR or COMPUTER CONTROL Setup and Operating Procedures" section of this manual.

For operational procedures and alarm responses refer to the appropriate sections in this manual.

To Set Up a Primary Infusion

1. Connect the PC-1 to an external AC power source using the power cord supplied by IMED.
2. Press the POWER ON control.
 - Verify that all indicators illuminate and all segments of the RATE and VTBI displays illuminate ("888.8" for both displays).
 - "PC-1 V7.xx" scrolls once across the operator information display (7.xx represents the installed software version).
 - Audio tone sounds once.
 - The delivery mode indicator illuminates according to the prior delivery mode selection, either PUMP or CONTROLLER.
 - The rate and VTBI displays will show "0" if the previous infusion was a MACRO delivery, or if the PC-1 is locked into MACRO delivery. The rate and VTBI displays will show "0.0" if the previous infusion was a MICRO delivery, or if the PC-1 is locked into MICRO delivery.
 - "SELECT P/C MODE" scrolls once if P/C mode is unlocked.
 - "SET RATE" will scroll.
 - "MACRO" or "MICRO" will scroll if the PC-1 is configured into either one.
 - "10 PSI" will scroll if locked in.

WARNING

If the instrument alarms "HELP INTERNAL ERROR", DO NOT USE THE INSTRUMENT. Send it to the Biomedical Department for inspection.

NOTE

If an administration set with open FLO-STOP is installed into the PC-1 before POWER ON is pressed, the PC-1 will automatically turn on and signal the "FLO-STOP" OPEN / CLOSE DOOR alarm.

3. Prepare the IV fluid container following accepted hospital procedure.
4. Open the GEMINI administration set package, remove set, and close the roller clamp.
5. Insert the set spike into the fluid container and hang the container a minimum of 24 inches above the PC-1 following accepted hospital procedure.
6. Fill the drip chamber to the fill line.
7. Open the roller clamp slowly to prime and clear any air from the injection sites and tubing fittings.
8. Close the roller clamp.

INDEPENDENT SETUP AND OPERATING PROCEDURES (continued)

9. Open the door. Install the administration set pumping chamber by properly positioning the upper fitment into the upper fitment recess, and then inserting the Flo-Stop fitment into the Flo-Stop recess below the pump mechanism, with the arrow pointing into the pump. Press the tubing into the air-in-line detector.
10. Close the door. Follow the specific instructions included with each type of GEMINI administration set.
11. Open the roller clamp.
12. Attach the set to the patient's indwelling venipuncture device following accepted hospital procedure.
13. Press the P/C MODE control to change delivery mode, if the P/C mode control is unlocked.
 - The appropriate delivery mode indicator illuminates.
14. Set the rate and VTBI.
 - a. Press the RATE control.
 - The last entered rate flashes.
 - "SET RATE" scrolls.
 - b. Use the appropriate data entry controls to change rate.
 - The new rate flashes.
 - "SET VTBI" scrolls.

NOTE

If the rate is greater than or equal to 100 mL/hr, the tenths (0.1) control is not functional. If the rate is in tenths, the hundreds (100) control is not functional. If not locked, pressing CLEAR/SILENCE will allow entry of either tenths or hundreds rate parameters.

- c. Press the VTBI control.
 - The last entered VTBI flashes.
- d. Use the appropriate data entry controls to change VTBI.
 - The new VTBI flashes.
 - The "PRESS START" prompt scrolls after 5 seconds.

NOTES

If the VTBI is greater than or equal to 1000 mL, the tenths (0.1) control is not functional. If not locked, pressing CLEAR/SILENCE will allow entry of either tenths or thousands. If the VTBI is greater than or equal to 1000 mL and a rate in tenths is selected, the VTBI will clear to a "0.0" when START is pressed.

A VTBI selection of "ALL" can only occur when the empty container detector (ECD) is attached. "ALL" will display after the VTBI has been cleared to "0" and the units key is pressed once, or the tenths key is pressed twice.

15. Press the START control.
 - The delivery mode and infusion parameters are entered.
 - The infusion is started.
 - The delivery mode indicator flashes according to the delivery mode selected.
16. Verify that the delivery mode indicator is flashing.

INDEPENDENT SETUP AND OPERATING PROCEDURES (continued)

NOTE

Immediate air-in-line alarm after initial setup and operation may indicate that the administration set is not properly installed in the air-in-line detector.

During infusion:

- The VTBI decrements.
- The volume infused increments (VOLUME INFUSED must be pressed to view).
- Various Advisories, Alarms, and Malfunctions may be displayed. Refer to the OPERATOR INFORMATION DISPLAY AND ALARM RESPONSE PROCEDURES section in this manual for an explanation and appropriate response.

Upon completion of the infusion:

- An audio prompt sounds.
- An "INFUSION COMPLETE-KVO" or "EMPTY CONTAINER-KVO" advisory scrolls.
- KVO infusion is initiated and shown in the RATE display.

To Pause an Infusion

1. Press the PAUSE/STOP control once.
 - The infusion stops.
 - The "PAUSE" advisory scrolls.
2. Press the START control to resume the infusion.





To Change Rate or VTBI During Infusion

1. Press the RATE control to change rate.
 - The current rate flashes.
2. Use the appropriate data entry controls to change rate.
 - The new rate flashes.
3. Press the VTBI control to change VTBI.
 - The current decremented VTBI flashes.
4. Use the appropriate data entry controls to change VTBI.
 - The new VTBI flashes.
5. Press the START control.
 - The infusion is started at the new infusion parameters.
 - The new rate or VTBI displays.

NOTE

If new rate and/or VTBI parameters have been selected, but not confirmed by pressing START or PAUSE; the currently confirmed parameters can be recalled by pressing Rate (VTBI), then pressing CLEAR/SILENCE and then pressing Rate (VTBI) again.

To Titrate RATE

1. Press the  or  control to change the rate parameter in 1 or 0.1 mL/hr increments
or
press and hold the  or  control to scroll to a new rate parameter.

INDEPENDENT SETUP AND OPERATING PROCEDURES (continued)

- The new rate display will begin flashing ≈0.5 seconds after the last input.
 - After 5 seconds, the "PRESS START" prompt starts scrolling.
2. Press START control.
 - The new rate is confirmed and displays steadily.
 - The instrument infuses at the new rate.

To Change Delivery Mode During Infusion (P/C Mode control unlocked)

1. Press the P/C MODE control.
 - The delivery mode indicator illuminates according to the new delivery mode selected.
 - The delivery mode indicator for the active infusion continues to flash.
2. Press the START control.
 - The new delivery mode is entered, and the indicator begins to flash.
 - The infusion is started at the new delivery mode.

To Restart an Infusion Following an "INFUSION COMPLETE - KVO" or "EMPTY CONTAINER - KVO" Advisory

1. Press the VTBI control to change VTBI.
 - A "0", or the current decremented VTBI, or "ALL" flashes (depending upon original setup).
 - The original rate displays.
2. Use the appropriate data entry controls to change VTBI.
 - The new VTBI flashes.
3. Refill drip chamber, if necessary.
4. Press the RATE control to change rate, if necessary.
5. Use the appropriate data entry controls to change rate.
 - The new rate flashes.
6. Press the START control.
 - The new delivery mode or infusion parameters are entered and the infusion is started.

To View Total Volume Infused

1. Press the VOLUME INFUSED control once.
 - The total volume infused flashes in the VTBI display for six seconds, or until the completion of the "TOTAL VOL INFUSED" scroll.
 - The display then reverts to previous status.

To View Secondary Volume Infused While in Secondary

1. Press the VOLUME INFUSED control twice.
 - The secondary volume infused flashes in the VTBI display for six seconds, or until the completion of the "SEC VOL INFUSED" scroll.
 - The display then reverts to previous status.

To Clear Total Volume Infused

1. Press VOLUME INFUSED control once.
2. Press CLEAR/SILENCE while the display is flashing to clear both the total and the secondary volume infused displays to "0".

NOTE

Volume Infused parameters cannot be cleared while displaying Secondary Volume Infused. Secondary Volume Infused automatically clears after changeover to Primary occurs.

INDEPENDENT SETUP AND OPERATING PROCEDURES (continued)

To Set Up Secondary (Piggyback) Infusion With Dual Rates

NOTE

The PC-1 will only allow Secondary infusion parameters in the same delivery modes (MACRO/ MICRO and PUMP/CONTROLLER) as the Primary parameters.

1. Set up and start the Primary infusion (using a check valve administration set) as previously described.
 - The Secondary infusion may be set up prior to or after starting a Primary infusion.
2. Prepare the Secondary fluid container following accepted hospital procedure.
3. Open the IMED SECONDARY administration set package, remove set, and close clamp.
4. Insert the set spike into the fluid container and hang the Secondary container following accepted hospital procedure.
5. Attach the enclosed needle to the Secondary set.
6. Fill the drip chamber at least 2/3 full.
7. Open Secondary clamp and prime the set. Close clamp.
8. Insert the Secondary set needle into the upper injection site on the Primary set.
9. Lower the Primary fluid container using the hanger provided with the Secondary set.
10. Press the SEC/PIGGYBACK control.
 - The Sec/Piggyback indicator flashes.
 - The RATE and VTBI displays show "SEC".
11. Press the RATE control.
 - The last entered Secondary rate flashes.
12. Use the appropriate data entry controls to change Secondary rate.
 - The new Secondary rate flashes.
13. Press the VTBI control.
 - The last entered Secondary VTBI or the current decremented Secondary VTBI flashes.
14. Use the appropriate data entry controls to change Secondary VTBI.
 - The new Secondary VTBI flashes.

NOTES

"ALL" is not an allowable VTBI for a Secondary (Piggyback) infusion. Do not use an ECD on a Secondary administration set.

Verify that the VTBI setting does not exceed the contents of the Secondary fluid container.

15. Open the clamp on the Secondary set.
 - The Secondary fluid will begin to flow.
16. Press the START control.
 - The Secondary infusion is started at the infusion parameters entered.
 - "SECONDARY" advisory scrolls.
 - The Sec/Piggyback indicator illuminates.

INDEPENDENT SETUP AND OPERATING PROCEDURES (continued)

During Secondary infusion:

- The Secondary VTBI decrements.
- Both the Secondary and the Total volumes infused increment (VOLUME INFUSED must be pressed to view).
- Various Advisories, Alarms, and Malfunctions may be displayed. Refer to the OPERATOR INFORMATION DISPLAY AND ALARM RESPONSE PROCEDURES section in this manual for an explanation of and the response to these Advisories, Alarms, and Malfunctions.

Upon completion of the Secondary infusion:

- The audio tone sounds six times, if enabled.
- The PC-1 automatically switches over to the Primary infusion parameters.
- The preset Primary rate and VTBI are displayed.
- The Sec/Piggyback indicator and the "SECONDARY" advisory cease.
- The delivery mode indicator flashes to confirm that Primary infusion parameters are in progress.
- "PRIMARY" will display until either PAUSE/STOP or START is pressed.
- The Secondary Volume Infused automatically clears.

NOTE

Actual changeover from the Secondary to the Primary IV solution is accomplished independently of pump/controller operation and occurs when the fluid level in the Secondary container drops to the same level as the fluid in the Primary administration set drip chamber.

To View or Change Primary Infusion Parameters During Secondary Infusion

1. Press the SEC/PIGGYBACK control.
 - The last entered Primary rate and VTBI flash.
2. Press the RATE control to change Primary rate.
3. Use the appropriate data entry controls to change Primary rate.
 - The new Primary rate flashes.
4. Press the VTBI control to change Primary VTBI.
5. Use the appropriate data entry controls to change Primary VTBI.
 - The new Primary VTBI flashes.
6. Press the SEC/PIGGYBACK control.
 - The new Primary delivery mode and infusion parameters are entered.

To Stop a Secondary Infusion and Return to the Primary Infusion

1. Press the SEC/PIGGYBACK control.
2. Close Secondary clamp.
3. Press the START control.
 - The Secondary infusion stops and the Primary infusion starts.
 - The Primary rate and VTBI display.
 - The "SECONDARY" advisory ceases.
 - The audio tone sounds six times.

INDEPENDENT SETUP AND OPERATING PROCEDURES (continued)

To Infuse Using an Empty Container Detector (ECD - Use an Empty Container Detector marked for Channel A only.)

1. Set up a Primary infusion.
2. Connect ECD (Channel A) or Universal ECD to the ECD connector on the rear panel of the PC-1 and attach the ECD sensor to the drip chamber of the Primary set.
3. Clear the Primary VTBI to "0".
4. Press the "1" (MACRO mode) or "0.1" (MICRO mode) control once to display "ALL", or set the desired VTBI.
5. Press the START control.

When the ECD senses an empty container:

- An audio prompt sounds.
- The "EMPTY CONTAINER - KVO" advisory scrolls.
- KVO infusion rate is initiated and shown in the RATE display.
- The delivery mode indicator flashes to indicate that the KVO infusion is in progress.

To Enter the VersaTaper or AutoTaper Mode

1. Confirm that the PC-1 is powered off.
2. Press the POWER ON control while simultaneously pressing and holding the VTBI control.
 - "888.8" will show in both displays.
 - "PC-1 V7.xx" scrolls once across the operator information display.
3. Release the VTBI control when the audio tone has sounded and "888.8" no longer shows in both displays.
 - "VersaTaper: Setup" will scroll.

NOTE

If "VersaTaper: Setup" does not scroll; repeat steps 1-3.

- To activate VersaTaper Setup - press START.

Press VTBI to select "AutoTaper: Ramp Time"

- "AutoTaper: Ramp Time" scrolls on the operator information display.
- To activate "AutoTaper Ramp Time" - press START.

Press VTBI again to select "AutoTaper: Setup"

- "AutoTaper: Setup" scrolls on the operator information display.
- To activate "Auto Taper Setup" - press START.

Press VTBI again to select "AutoTaper: Patient"

- "AutoTaper: Patient" scrolls on the operator information display.
- To activate "AutoTaper: Patient" - press START.

Press VTBI once again to select Powerdown

- "Powerdown" scrolls on the operator information display.
- Press START to power down.

NOTE

VTBI control may be pressed again to return to VersaTaper: Setup

INDEPENDENT SETUP AND OPERATING PROCEDURES (continued)

NOTE

Controller delivery mode and empty container detector operation are not available for use in VersaTaper, AutoTaper and AutoTaper Patient modes.

VERSATAPER MODE

To Set Up a VersaTaper Infusion

1. Follow instructions listed above under To Enter VersaTaper or AutoTaper mode to select VersaTaper: Setup
 - The Pump delivery mode indicator illuminates.
 - Previously entered parameters for STEP 01 will display.
 - "VERSATAPER: SETUP" will scroll.
 - "MACRO" or "MICRO" will scroll if STEP 01 parameters were entered in a previous program.
 - "10 PSI" will scroll if locked in.
2. Press the RATE control and set the desired rate for VersaTaper STEP 01.
 - The "STEP: 01" advisory will display.
3. Press the VTBI control and set the desired VTBI for VersaTaper STEP 01.
4. Press the START control.
 - The "STEP: 01" advisory will be replaced by "STEP: 02" and previously programmed parameters for STEP 02 will display. (If STEP 02 was not previously programmed, zeros will display.)
5. Repeat instructions 3, 4, and 5 to program VersaTaper STEP 02. At the end of instruction 5, the "STEP: 02" advisory will be replaced by "STEP: 03".
6. Repeat this cycle to program VersaTaper STEPS 03 through 20, as required.
7. Press PAUSE/STOP once to enter all programmed VersaTaper parameters.
 - STEP 01 rate and VTBI parameters will display.
 - The following advisories will scroll:
 - a. "STEPS: (number of STEPS programmed)"
 - b. "TOTAL VOL: (total VTBI for all STEPS programmed)"
 - c. "DURATION: (total time in hours and minutes to complete all STEPS programmed)".

If desired, press START to view each of the programmed VersaTaper STEP parameters in sequence. VersaTaper STEP parameters can also be changed, if required, following instructions 3, 4, and 5.

NOTE

To clear all parameters of the viewed STEP and all subsequent STEPS to "0", press RATE, CLEAR/SILENCE, VTBI, CLEAR/SILENCE, and START.

8. Press PAUSE/STOP a second time to power off the instrument. The VersaTaper infusion is programmed and ready for operation when the instrument comes up in VersaTaper Mode at next power on. If the instrument is powered off after clearing all STEP parameters to zero, then the instrument will come up in the normal infusion mode at next power on.

To Operate a VersaTaper Infusion

1. Prepare the Primary infusion as described in the non-VersaTaper Mode setup section.

INDEPENDENT SETUP AND OPERATING PROCEDURES (continued)

2. Press the POWER ON control.
 - "888.8" will show in both displays and "PC-1 V x.xx" scrolls once.
 - Audio tone sounds once.
 - " - - - -" appears in the rate and VTBI displays.
 - The "VERSATAPER" advisory will scroll.
3. If desired, press VOLUME INFUSED and CLEAR/SILENCE to clear the Total Volume Infused to "0" before beginning the VersaTaper infusion.
4. Press and hold the P/C MODE control for at least one second.
 - STEP 01 rate and VTBI parameters will display.
 - "STEP: 01" and "TIME LEFT: xx:xx" will scroll.
 - The "PRESS START" prompt will scroll and an audio tone will begin to sound.
5. Press the START control.
 - The instrument will begin the VersaTaper infusion with STEP 01, and will continue through the STEPS of the program until the last STEP is completed.
 - The rate of the active STEP will display.
 - The VTBI of the active STEP will decrement.
 - "STEP: xx TIME LEFT: xx:xx VERSATAPER" will scroll continuously throughout the VersaTaper infusion.
 - The total volume infused increments as the programmed VersaTaper STEPS infuse in sequence. (Press VOLUME INFUSED to view.)

NOTE

During the VersaTaper infusion, press RATE to view each of the programmed STEP parameters in sequence. (No changes can be made.) The display will automatically revert to the current STEP number and will display STEP parameters after approximately 6 seconds, or press VTBI to cancel the viewing.

Upon completion of the infusion:

- An audio prompt sounds.
- An "INFUSION COMPLETE - KVO" or "EMPTY CONTAINER - KVO" advisory scrolls.
- A KVO infusion is initiated and shown in the RATE display.
- A VersaTaper infusion may not be restarted from the KVO state.

To Stop a VersaTaper Infusion

1. Press PAUSE/STOP control twice:
 - "OFF 3" displays; "3" decrements to "1" and then the instrument powers down.

To Resume a VersaTaper Infusion

1. Press POWER ON control to power on the instrument:
 - Following initialization "VERSATAPER" will scroll.
 - The RATE and VTBI displays will show " - - - -".
 - The operating indicator for the last selected delivery mode will illuminate.
2. Press P/C MODE control for 1 second:
 - The rate and VTBI for the last active Step will appear in the RATE and VTBI displays.



INDEPENDENT SETUP AND OPERATING PROCEDURES (continued)

- "CONTINUE PREVIOUS INFUSION? ↑ = YES ↓ = NO STEP xx TIME LEFT xx:xx VERSATAPER" will scroll.
- After 30 seconds, Audio prompt will sound.
- a. Press  to continue the previous infusion:
 - "YES" will appear in the VTBI display.
 - "PRESS START" will scroll.
 - After 30 seconds, audio prompt will sound.
- b. Press START control twice:
 - Previous infusion will resume from the point it was stopped.
 - "STEP: xx TIME LEFT: xx:xx VERSATAPER" will scroll.
 - Pump mode operating indicator will flash

or
- c. Press  to reset the instrument to the beginning of the programmed VersaTaper infusion:
 - "no" will appear in the VTBI display.
 - "PRESS START" will scroll.
- d. Press START control twice to begin a new VersaTaper infusion:
 - "STEP: xx TIME LEFT: xx:xx VERSATAPER" will scroll.
 - RATE and VTBI displays will show the rate and VTBI for Step 01.
 - The pump mode operating indicator will flash.

AUTOTAPER MODE (must be entered from VersaTaper: Setup using VTBI key)

To Select AutoTaper Ramp Time

1. Press START:
 - "ramp xx%" displays statically (xx = either the last selected ramp % or the default value of 8%).
 - Use the  or  to increment or decrement ramp (%) between 6% minimum and 12% maximum.

To Setup an AutoTaper infusion

1. Press VTBI control once:
 - "AutoTaper: Setup" scrolls.
2. Press START:
 - "SET VTBI" and "AUTOTAPER: SETUP" scroll.
 - " - - - - " appears in the VTBI display.
 - The PUMP delivery mode indicator illuminates.
3. Press the VTBI control:
 - Last selected VTBI or "0" flashes in the VTBI display.
 - Use the data entry controls to set the VTBI (between 200 mL minimum and 7896 mL maximum).
4. Press START:
 - Entered VTBI value displays steadily.
 - "SET DURATION" scrolls.
 - Last selected time factor "xx:xx" displays statically alternating with the scrolled message.
 - Use the "1", "10" and CLEAR/SILENCE controls to set delivery time (between 1 and 24 hours).

INDEPENDENT SETUP AND OPERATING PROCEDURES (continued)

5. Press START:
 - AutoTaper summary message scrolls "DURATION: xx:xx MAX RATE: xxx RAMP %: xx".

NOTE

Entry of a volume/time parameter that results in a max rate >350 mL/hr will cause the "VOLUME/TIME ERROR: SET VTBI" message to scroll

6. Press PAUSE/STOP control once to power down:
 - "OFF n" displays; "n" decrements to 1 and then the instrument powers down.

To Operate an AutoTaper infusion

1. Prepare the infusion as described in the Primary infusion setup section.
2. Press POWER ON to initialize the instrument:
 - "888.8" will display in both displays and "PC-1 v7.xx" scrolls once.
 - Audio tone sounds once.
 - PUMP delivery mode indicator illuminates.
 - " - - - - " appears in both the RATE and VTBI displays.
 - "AUTOTAPER" scrolls
3. Press the P/C mode control to enable the START control for the AutoTaper infusion.
4. Press the START control:
 - RATE display dynamically shows the rate value for that increment of the ramp currently being evoked.
 - VTBI display shows the total volume to be infused.
 - "TIME LEFT: xx:xx AUTOTAPER" scrolls continuously (the time display is dynamic and displays the actual time remaining).
 - The delivery mode operating indicator flashes to confirm the infusion is in progress.

To Stop an AutoTaper Infusion

1. Press PAUSE/STOP control twice:
 - "OFF 3" displays; "3" decrements to "1" and then the instrument powers down.



To Resume an AutoTaper Infusion

1. Press POWER ON control to power on the instrument:
 - Following initialization, "AUTOTAPER" scrolls.
 - RATE and VTBI displays show " - - - - ".
 - Delivery mode operating indicator for the previously selected delivery mode illuminates.
2. Press and hold P/C MODE control for 1 second:
 - The rate and the volume remaining to be infused when the infusion was stopped will appear in the RATE and VTBI displays.
 - "CONTINUE LAST xx:xx OF PREVIOUS INFUSION? ↑ = YES ↓ = NO AUTOTAPER" will scroll.
 - After 30 seconds, Audio prompt will begin.
- a. Press  to continue the previous infusion:
 - "YES" will appear in the VTBI display.
 - "PRESS START" will scroll.
 - "CONTINUE LAST xx:xx OF PREVIOUS INFUSION? ↑ = YES ↓ = NO" will scroll.
 - After 30 seconds, audio prompt will begin.

INDEPENDENT SETUP AND OPERATING PROCEDURES (continued)

- b. Press START control twice:
 - Previous infusion will resume from the point it was stopped.
 - "TIME LEFT: xx:xx AUTOTAPER" will scroll.
 - Delivery mode operating indicator will flashor
- c. Press  to reset the instrument to the beginning of the infusion:
 - "no" will appear in the VTBI display.
 - "PRESS START" will scroll.
 - "CONTINUE LAST xx:xx OF PREVIOUS INFUSION? ↑ = YES ↓ = NO" will scroll.
- d. Press START control once:
 - "TIME LEFT: xx:xx PRESS START AUTOTAPER" will scroll.
 - VTBI display will show the programmed VTBI .
 - After 30 seconds, audio prompt will sound.
- e. Press START control again to start infusion:
 - "TIME LEFT: xx:xx AUTOTAPER" will scroll.
 - RATE display will show the current operating rate.
 - VTBI display will show the programmed volume to be infused.
 - The pump mode operating indicator will flash.

To Enable an AutoTaper: Patient infusion

1. Following initialization in the VersaTaper and AutoTaper setup mode, press the VTBI control until "AutoTaper: Patient" scrolls on the operator information display.
2. Press START control:
 - "enabled" or "disabled" will appear statically on the operator information display.
 - The delivery mode operating indicator for the last selected delivery mode will illuminate.
3. Use the  or  controls to select "enabled", if necessary.
4. Press VTBI control to select "Powerdown".
5. Press START to power down the instrument.

To Set Up and Operate an AutoTaper Patient Infusion

1. Press POWER ON to power up the instrument (AutoTaper Patient mode must be enabled):
 - "AUTOTAPER: PATIENT" scrolls.
 - RATE and VTBI displays show " - - - - ".
 - The Pump delivery mode indicator illuminates.
2. Press and hold the P/C MODE control for 1 second:
 - "SET VTBI" scrolls.
 - RATE display is blank.
 - VTBI display shows " - - - - ".
 - After 30 seconds, audio prompt sounds.
3. Press VTBI control:
 - Last selected VTBI or "0" flash in the VTBI display.
 - After 30 seconds, audio prompt sounds.
 - Use data entry controls to set VTBI.
4. Press START control:
 - Selected VTBI value displays steadily.
 - "SET DURATION" scrolls.
 - "xx:xx" displays statically alternating with scrolled message(s).
 - Use "10" or "1" data entry controls to set duration.

INDEPENDENT SETUP AND OPERATING PROCEDURES (continued)

5. Press START control:
 - "DURATION: xx:xx MAX RATE: xxx RAMP %: XX" and "PRESS START" scroll.
 - After 30 seconds, audio prompt sounds.

NOTE



Entry of a volume/time parameter that results in a maximum rate >350 mL/hr will cause the "VOLUME/TIME ERROR: SET VTBI" message to scroll.

6. Press START control again to start infusion:
 - "TIME LEFT: xx:xx AUTOTAPER" scrolls.
 - RATE display shows active delivery rate.
 - VTBI display shows volume to be infused.
 - The pump delivery mode indicator flashes.

To Stop an AutoTaper Patient Infusion

1. Press PAUSE/STOP twice:
 - "OFF 3" displays; "3" decrements to "1" and then the instrument powers down.

To Resume an AutoTaper Patient Infusion

1. Press POWER ON control to power on the instrument:
 - Following initialization, "AUTOTAPER: PATIENT" scrolls..
 - RATE and VTBI displays show " - - - -".
 - The pump delivery mode indicator illuminates.
 2. Press and hold P/C MODE control for 1 second:
 - The active rate and the volume remaining to be infused when the infusion was stopped will appear in the RATE and VTBI displays.
 - "CONTINUE LAST xx:xx OF PREVIOUS INFUSION? ↑ = YES ↓ = NO AUTOTAPER" will scroll.
 - After 30 seconds, Audio prompt will begin.
 - a. Press  to continue the previous infusion:
 - "YES" will appear in the VTBI display.
 - "PRESS START" will scroll.
 - "CONTINUE LAST xx:xx OF PREVIOUS INFUSION? ↑ = YES ↓ = NO" will scroll.
 - After 30 seconds, audio prompt will begin.
 - b. Press START control:
 - RATE and VTBI displays will show parameters active when infusion was stopped.
 - "TIME LEFT: xx:xx PRESS START AUTOTAPER" will scroll.
 - After 30 seconds, audio prompt will sound.
 - c. Press START to resume previous autotaper infusion:
 - The pump delivery mode operating indicator will flash.
 - "TIME LEFT xx:xx AUTOTAPER" will scroll
- or
- d. Press  to reset the instrument to the beginning of the infusion.
 - "no" will appear in the VTBI display.
 - "PRESS START" will scroll.
 - "CONTINUE LAST xx:xx OF PREVIOUS INFUSION? ↑ = YES ↓ = NO" will scroll.
 - After 30 seconds, audio prompt will sound.

INDEPENDENT SETUP AND OPERATING PROCEDURES (continued)

- e. Press START control once:
 - "SET VTBI" will scroll.
 - RATE display will be blank.
 - VTBI display will show " - - - -".
 - After 30 seconds, audio prompt will sound.
3. Follow steps 3-6 in Section: **To setup and operate an AutoTaper Patient infusion.**

To Exit the VersaTaper/AutoTaper Mode

1. Press the PAUSE/STOP control twice, which will power off the instrument.
2. Press the POWER ON control while simultaneously pressing and holding the CLEAR/SILENCE control until an audio tone has sounded.
3. The PC-1 may now be operated as described in the normal infusion mode sections of this manual.

To Clear Alarms

1. Check the operator information display to determine the type of alarm condition.
2. Refer to the OPERATOR INFORMATION DISPLAY AND ALARM RESPONSE PROCEDURES section in this manual for the proper procedures for responding to a specific alarm condition.

To Power Off the PC-1

1. Press the PAUSE/STOP control twice:
 - The infusion stops.
 - All displays extinguish.

During the power off sequence:

- Operator information display shows "OFF 3", where "3" represents the count down to power off in seconds.
- The display counts down from "3" to "1". Upon reaching "1", the PC-1 automatically powers off.

NOTE

To interrupt the power off sequence, press the PAUSE/STOP control prior to the count-down timer in the operator information display reaching "1". To resume the infusion, press START and verify that the delivery mode indicator is flashing.

MONITOR OR COMPUTER CONTROL SETUP AND OPERATING PROCEDURES

Introduction

The steps necessary to set up the PC-1 for Monitor or Computer Control Operation are described in the following paragraphs.

To Establish PC-1/Host Computer Interface

1. Set computer communication parameters.

NOTE

Before the PC-1 can be used in the Monitor or Computer Control Operation conditions, the computer communication parameters must be set by hospital technical personnel, both in the host computer and in the PC-1. Thorough familiarity with independent operation of the PC-1 is a prerequisite for technical personnel responsible for configuring the pump/controller for remote operation. The procedures for setting the computer communication parameters for the PC-1 are provided in the IMED C-2 Programmer's Guide.

2. Connect the communication interface cable to the RS-232-C communication DATA PORT connector (rear panel) of the PC-1.

NOTE

Before the PC-1 can be set up for either Monitor or Computer Control Operation, the communication interface cable must be connected to the RS-232-C communication DATA PORT connector on the rear panel of the PC-1. The technical data necessary to interface the host computer interface cable to the PC-1's RS-232-C Communication DATA PORT connector is provided in the PC-1 Maintenance Manual.

When power is then applied to the PC-1's circuits, the MONITOR indicator will illuminate.

- a. **To Change PC-1 Operating Condition from Independent to Monitor,** connect the communication interface cable to the RS-232-C communication DATA PORT connector (rear panel) of the PC-1.
 - The MONITOR indicator illuminates.
- b. **To Change PC-1 Operating Condition from Monitor to Computer Control,** press the COMPUTER CONTROL/MONITOR control.
 - The COMPUTER CONTROL indicator flashes and the MONITOR indicator goes off.
 - When 2-way communications are established and the host computer takes control, the COMPUTER CONTROL indicator illuminates.
 - The host computer starts the infusion. The infusion cannot be started from the PC-1 after the computer establishes control.

MONITOR OR COMPUTER CONTROL SETUP AND OPERATING PROCEDURES (continued)

- PC-1 keypad is inoperative, except for the PAUSE and COMPUTER CONTROL/MONITOR controls.
 - The delivery mode indicator flashes according to the delivery mode selected.
 - The communication traffic indicator flickers when communication between the host computer and the PC-1 is taking place.
- c. **To Change PC-1 Operating Condition from Computer Control to Monitor**, press the COMPUTER CONTROL/MONITOR control.
- The COMPUTER CONTROL indicator goes off and the MONITOR indicator illuminates.
- d. **To Change PC-1 Operating Condition From Monitor to Independent**, disconnect the communication interface cable from the RS-232-C communication DATA PORT connector (rear panel) of the PC-1.
- The MONITOR indicator goes off.

To Set Up a Primary Infusion

1. Connect the PC-1 to an external AC power source using the power cord supplied by IMED.
2. Press the POWER ON control.
 - Verify that all indicators illuminate and all segments of the RATE and VTBI displays illuminate ("888.8" for both displays).
 - "PC-1 V7.xx" scrolls once across the operator information display (7.xx represents the installed software version).
 - An audio tone sounds once.
 - The delivery mode indicator illuminates according to the prior delivery mode selection, either PUMP or CONTROLLER.
 - The rate and VTBI displays will show "0" if the previous infusion was a MACRO delivery, or if the PC-1 is locked into MACRO delivery.
 - The rate and VTBI displays will show "0.0" if the previous infusion was a MICRO delivery, or if the PC-1 is locked into MICRO delivery.
 - "SELECT P/C MODE" scrolls once if P/C mode is unlocked.
 - "SET RATE" will scroll.
 - "MACRO" or "MICRO" will scroll if the PC-1 is configured into either one.
 - "10 PSI" will scroll if locked in.
 - MONITOR indicator illuminates.

WARNING

If the instrument alarms "HELP INTERNAL ERROR", **DO NOT USE THE INSTRUMENT**. Send it to the Biomedical Department for inspection.

NOTE

If an administration set with open FLO-STOP is installed into the PC-1 before POWER ON is pressed, the PC-1 will automatically turn on and signal the FLOW STOP OPEN/CLOSE DOOR alarm.

MONITOR OR COMPUTER CONTROL SETUP AND OPERATING PROCEDURES (continued)

3. Prepare the IV fluid container following accepted hospital procedure.
4. Open the GEMINI administration set package, remove set, and close the roller clamp.
5. Insert the set spike into the fluid container and hang the container a minimum of 24 inches above the PC-1 following accepted hospital procedure.
6. Fill the drip chamber to the fill line.
7. Open the roller clamp slowly to prime and clear any air from the injection sites and tubing fitments.
8. Close the roller clamp.
9. Open the door. Install the administration set pumping chamber by placing the upper fitment into the upper fitment recess, and then inserting the Flo-Stop fitment into the Flo-Stop recess below the pump mechanism, with the arrow pointing into the pump. Press the tubing into the air-in-line detector.
10. Close the door. Follow the specific instructions included with each type of GEMINI administration set.
11. Open the roller clamp.
12. Attach the set to the patient's indwelling venipuncture device following accepted hospital procedure.
13. Press the P/C MODE control to change delivery mode (if the P/C mode control is unlocked).
 - The appropriate delivery mode indicator illuminates.
14. If in MONITOR operation, set the rate and VTBI. (If in CONTROL operation, the rate and VTBI will be set by the host computer.)
 - a. Press the RATE control.
 - The last entered rate flashes.
 - "SET RATE" scrolls.
 - b. Use the appropriate data entry controls to change rate.
 - The new rate flashes.
 - "SET VTBI" scrolls.

NOTE

If the rate is greater than or equal to 100 mL/hr, the tenths (0.1) control is not functional. If the rate is in tenths, the hundreds (100) control is not functional. If not locked, pressing CLEAR/SILENCE will allow entry of either tenths or hundreds rate parameters.

- c. Press the VTBI control.
 - The last entered VTBI flashes.
 - "SET VTBI" scrolls.
- d. Use the appropriate data entry controls to change VTBI.
 - The new VTBI flashes.
 - The "PRESS START" prompt scrolls after 5 seconds.

NOTE

If the VTBI is greater than or equal to 1000 mL, the tenths (0.1) control is not functional. If not locked, pressing CLEAR/SILENCE will allow entry of either tenths or thousands. If the VTBI is greater than or equal to 1000 mL and a rate in tenths is selected, the VTBI will clear to a "0.0" when START is pressed.

MONITOR OR COMPUTER CONTROL SETUP AND OPERATING PROCEDURES (continued)

NOTE

A VTBI selection of "ALL" can only occur when the empty container detector (ECD) is attached. "ALL" will display after the VTBI has been cleared to "0" and the units key is pressed once, or the tenths key is pressed twice.

15. If in **MONITOR operation**, press the START control to begin the infusion.
 - The delivery mode and infusion parameters are entered.
 - The infusion is started.
 - The delivery mode indicator flashes according to the delivery mode selected.

16. If in **CONTROL operation**, press the COMPUTER CONTROL/MONITOR switch.
 - The COMPUTER CONTROL indicator flashes and the MONITOR indicator goes off.
 - When a valid command is received by the PC-1 via the RS-232C Communications Data Port, the COMPUTER CONTROL indicator illuminates.
 - The host computer starts the infusion. (An infusion cannot be started from the PC-1 while the COMPUTER CONTROL indicator is illuminated steadily.)

NOTE

Immediate air-in-line alarm after initial setup and operation may indicate that the administration set is not properly installed in the air-in-line detector.

During infusion:

- The VTBI decrements.
- The volume infused increments (VOLUME INFUSED must be pressed to view). Various Advisories, Alarms, and Malfunctions may be displayed. Refer to the OPERATOR INFORMATION DISPLAY AND ALARM RESPONSE PROCEDURES section in this manual for an explanation and appropriate response.
- The communication traffic indicator flickers when communication between the host computer and the PC-1 is active.

Upon completion of the infusion:

- An audio prompt sounds.
- An "INFUSION COMPLETE-KVO" or "EMPTY CONTAINER-KVO" advisory scrolls.
- KVO infusion is initiated and shown in the RATE display.

To Power Off the PC-1 in MONITOR Operation

1. Press the PAUSE/STOP control twice.
 - The infusion stops.
 - All displays cease.

MONITOR OR COMPUTER CONTROL SETUP AND OPERATING PROCEDURES (continued)

To Power Off the PC-1 in COMPUTER Operation

1. Press the COMPUTER CONTROL/MONITOR switch.
 - The COMPUTER CONTROL indicator turns off.
 - The MONITOR indicator illuminates.
2. Press the PAUSE/STOP control twice.
 - The infusion stops.
 - All displays cease.

During the power off sequence:

- Operator information display shows "OFF 3", where "3" represents the count down to power off in seconds.
- The display counts down from "3" to "1". Upon reaching "1", the PC-1 automatically powers off.

NOTE

To interrupt the power off sequence, press the PAUSE/STOP control prior to the count-down timer in the operator information display reaching "1".

NOTES

The operating procedures listed below are identical for both MONITOR operation and Independent operation. Refer to the Independent Setup section of this manual for the detailed descriptions.

These operating procedures during COMPUTER CONTROL operation are performed by the host computer, and are described in the IMED C2 Programmer's Guide, IMED P/N 1320-9004-00.

- To Pause an Infusion
- To Change Rate or VTBI During Infusion
- To Change Delivery Mode During Infusion (P/C Mode control unlocked)
- To Restart an Infusion Following an "INFUSION COMPLETE - KVO" or "EMPTY CONTAINER - KVO" Advisory
- To View Total Volume infused
- To View Secondary Volume Infused While in Secondary
- To Clear Total Volume Infused
- To Set Up Secondary (Piggyback) Infusion With Dual Rates
- To View or Change Primary Infusion Parameters During Secondary Infusion
- To Stop a Secondary Infusion and Return to the Primary Infusion
- To infuse Using an Empty Container Detector (ECD - Use an Empty Container Detector marked for Channel A only.)
- To Enter the VersaTaper Mode
- To Operate a VersaTaper Infusion
- To Exit the VersaTaper Mode
- To Clear Alarms

OPERATOR INFORMATION DISPLAY AND ALARM RESPONSE PROCEDURES

The Operator Information Display displays four types of information: advisories, prompts, alarms, and malfunctions.





The characteristics of the accompanying audio sounds are as follows:





| Type | Sound | Notes |
|-------------|--------------------------------------|--|
| changeover | six short beeps | variable volume; can be silenced and disabled in the SETUP mode |
| prompt | one short beep every two seconds | variable volume; can be silenced |
| key click | one short beep | variable volume; can be silenced |
| advisory | one short beep every fifteen seconds | variable volume; can be silenced |
| alarm | one long beep every 1.5 seconds | variable volume; can be silenced |
| malfunction | pairs of long beeps | fixed 75 decibel volume; cannot be silenced |

An **ADVISORY** is a sequence of audio and/or visual signals to advise the user of the operating status of the PC-1. The audio may be silenced for ~2 minutes by pressing the CLEAR/SILENCE control.

| Advisory | Meaning | Response |
|--|--|--|
| SECONDARY Audio: changeover when SEC complete Visual: continuous scroll | Secondary infusion in progress. | None. |
| PRIMARY Audio: none Visual: continuous scroll | SEC/PIGGYBACK pressed while operating in Secondary, or automatic changeover from Secondary to Primary has taken place. | None. (Press START to clear advisory.) |
| INFUSION COMPLETE - KVO Audio: prompt Visual: continuous scroll | VTBI has been infused; PC-1 is infusing at KVO rate. | Turn off PC-1, or set up new infusion. |
| SETUP Audio: Prompt Visual: continuous scroll | Instrument has been powered up in the SETUP mode. | DO NOT USE ON PATIENT. |

| Advisory (continued) | Meaning | Response |
|---|---|---|
| EMPTY CONTAINER - KVO Audio: prompt Visual: continuous scroll | Empty container detected by ECD before programmed VTBI delivered, or when "ALL" has been used as the VTBI infusion parameter. PC-1 is infusing at KVO rate. ECD plugged into PC-1, but not attached to drip chamber. | Replace IV container, turn off PC-1, or set up new infusion. Attach ECD to drip chamber. |
| LOW BATTERY Audio: prompt Visual: continuous scroll; parameters flash | Low battery threshold sensed, remaining battery operational life is limited. | Connect AC power cord to outlet; alarm will be silenced. |
| DIAGNOSTIC Audio: key click Visual: continuous scroll | Instrument powered up in the diagnostic mode. | DO NOT USE ON PATIENT. Check with biomedical department. |
| PAUSE Audio: advisory, then prompt after two minutes Visual: continuous scroll | PAUSE/STOP control has been pressed once. | Press START control to resume infusion, or press PAUSE/STOP a second time to stop infusion. |
| POWER OFF Audio: none Visual: static display | PAUSE/STOP control has been pressed twice. | None. |
| 10 PSI Audio: none Visual: intermittent scroll | Pump mode is locked into 10 (± 2) psi occlusion detection at all flow rates. | None. Time to occlusion at low rates will be significantly increased. |
| LOW FLOW Audio: advisory Visual: continuous scroll | Flow has slowed due to backpressure equalling container height. An occlusion alarm will occur within one minute. | Check tubing for restriction, raise container, press START, or change to pump delivery mode (if P/C Mode control unlocked). |
| TOTAL VOL INFUSED Audio: none Visual: single scroll | VOLUME INFUSED control pressed once. | None; numeric value in VTBI display is cumulative. |
| SEC VOL INFUSED Audio: none Visual: single scroll | VOLUME INFUSED control pressed twice while in Secondary. | None; numeric value in VTBI display reflects volume of secondary. |
| MACRO Audio: none Visual: continuous scroll | Can only set up using MACRO parameters. | None; PC-1 is locked in MACRO configuration. |
| MICRO Audio: none Visual: continuous scroll | Can only set up using MICRO parameters. | None; PC-1 is locked in MICRO configuration. |
| PANEL LOCKED Audio: key click Visual: continuous scroll | Audio control has been pressed and held for 3 seconds with tamper-resistant feature enabled. | None. Repeat to cancel tamper-resistance |

| Advisory (continued) | Meaning | Response |
|--|---|---|
| VersaTaper: Setup Audio: none Visual: continuous scroll | PC-1 has been initialized in the VersaTaper Setup Mode. | Press START to set up a VersaTaper infusion. |
| STEP: xx Audio: none Visual: single if programmed, continuous if infusing | VersaTaper mode Only Specifies which Step is accessed, either for programming or for viewing. | None; either program or view this Step's parameters. |
| STEPS: xx Audio: none Visual: continuous scroll | Summarizes number of Steps that have been programmed. | None. |
| TOTAL VOL: xx Audio: none Visual: continuous scroll | Summarizes total volume of all VersaTaper programmed steps. | None. |
| DURATION: xx:xx Audio: none Visual: continuous scroll | Summarizes total time required to infuse all VersaTaper programmed Steps. | None. |
| VERSATAPER Audio: none Visual: continuous scroll | PC-1 ready or operating in VersaTaper Mode. | If in ready condition, press START to begin VersaTaper infusion. |
| TIME LEFT: xx:xx Audio: none Visual: continuous scroll | Time remaining to complete the VersaTaper infusion. | None. |
| CONTINUE PREVIOUS INFUSION? ↑=YES ↓=NO STEP: xx TIME LEFT: xx:xx VERSATAPER Audio: none Visual: continuous scroll | VersaTaper infusion has been reentered after an incompleted prior infusion. | Use the  or  controls to continue or discontinue previous infusion. |
| CONTINUE PREVIOUS INFUSION? ↑=YES ↓=NO Audio: none Visual: continuous scroll | The Yes option to continue the previous infusion has been selected. | None. Pressing ↓ will change the selection from continue to discontinue. |
| yes Audio: none Visual: static display | The Yes option to continue the previous AutoTaper/ VersaTaper infusion has been selected. | Press START to resume previous infusion. |
| no Audio: none Visual: static display | The No option to discontinue the previous AutoTaper/VersaTaper infusion has been selected. | Press START to begin a new infusion. |
| AutoTaper: Ramp Time Audio: none Visual: continuous scroll | AutoTaper Ramp Time setup mode has been selected. | Press START to enable ramp time (%) selection. |
| ramp% xx Audio: none Visual: static display | AutoTaper ramp% selection mode is enabled. | Use  or  to select ramp % (between 6 and 12%, default setting 8%). |

| Advisory (continued) | Meaning | Response |
|---|--|---|
| AutoTaper: Setup Audio: none Visual: continuous scroll | AutoTaper setup mode has been selected. | Press START to enable selection of AutoTaper infusion parameters. |
| AUTOTAPER: SETUP Audio: none Visual: continuous scroll | AutoTaper setup mode has been enabled. | Use infusion parameter entry controls to program AutoTaper infusion. |
| SET DURATION Audio: none Visual: alternating scroll | AutoTaper setup mode is ready for infusion duration input. | Use "10" and or "1" controls to set duration (between 1 and 24 hours). |
| DURATION: xx:xx MAX RATE: xxx RAMP %: xx Audio: none Visual: continuous scroll | AutoTaper Setup summary message. | None. Press PAUSE/STOP to exit AutoTaper: Setup. |
| AUTOTAPER Audio: none Visual: continuous scroll | PC-1 is ready or operating in AutoTaper mode. | If in ready condition, press and hold P/C MODE control for 1 second; then press START. |
| TIME LEFT: xx:xx AUTOTAPER Audio: none Visual: continuous scroll | PC-1 is ready or performing an AutoTaper infusion. | None. |
| CONTINUE LAST xx:xx OF PREVIOUS INFUSION? ↑=YES ↓=NO AUTOTAPER Audio: none Visual: continuous scroll | AutoTaper infusion has been reentered after an incompleted prior infusion. | Use the  or  controls to continue or discontinue previous infusion. |
| AutoTaper: Patient Audio: none Visual: continuous scroll | AutoTaper Patient mode enable has been selected. | Use  or  controls to enable or disable AutoTaper Patient infusion mode. |
| enabled Audio: none Visual: static display | AutoTaper Patient mode has been enabled. | Press VTBI, then START to exit AutoTaper: Patient setup mode. |
| disabled Audio: none Visual: static display | AutoTaper Patient mode has been disabled. | Press VTBI, then START to exit AutoTaper: Patient setup mode. |
| VOLUME/TIME ERROR: SET VTBI Audio: none Visual: continuous scroll | Volume and/or time input resulted in a max rate >350 mL/hr. | Press VTBI control to re-enter volume and/or time parameter. |

A **PROMPT** is an audio and/or visual signal to the user to perform some action. The audio may be silenced for 2 minutes by pressing the CLEAR/SILENCE control.

| Prompt | Meaning | Response |
|---|---|--|
| SELECT P/C MODE Audio: none Visual: one scroll | Begins following press of POWER ON control, if P/C Mode control is unlocked. | Select Pump or Controller delivery mode, as appropriate. |
| SET RATE Audio: prompt Visual: continuous scroll | Begins following press of POWER ON control, or if START control is pressed with rate set to "0". | Press RATE control and enter rate. |
| SET VTBI Audio: prompt Visual: continuous scroll | Begins following press of RATE control, or if START control is pressed with VTBI set to "0". | Press VTBI control and enter VTBI. |
| PRESS START Audio: prompt after 12 seconds Visual: continuous scroll | Begins 5 seconds after last press of data entry controls if neither parameter is zero, or immediately after clearing a DOOR OPEN or FLO-STOP alarm. | Press START control. |

An **ALARM** is an audio and visual signal to the user that an unsafe condition is present. Immediate action is required. Except during a "FLO-STOP" OPEN / CLOSE DOOR condition, the audio may be silenced for ≈2 minutes by pressing the CLEAR/SILENCE control.

| Alarm | Meaning | Response |
|---|---|--|
| CHECK ECD Audio: alarm Visual: continuous scroll | ECD has been disconnected during an "ALL" infusion, or ECD has failed. Infusion stops. | Connect or repair ECD, then press START control. |
| CHECK IV SET Audio: alarm Visual: continuous scroll | Administration set not properly installed. Infusion stops. | Close roller clamp, remove and re-install administration set, close door, open roller clamp. |
| CLOSE DOOR Audio: alarm Visual: continuous scroll | Door opened during an infusion, with Flo-Stop closed. Infusion stops. | Close door, press START control. |
| AIR-IN-LINE Audio: alarm Visual: continuous scroll | Air-in-line detector activated during an infusion. Infusion stops. | Ensure tubing is in detector. If air is present, clear air from administration set. Press START control. |
| OCCLUDED PATIENT SIDE Audio: alarm Visual: continuous scroll | Increased backpressure sensed while infusing in the Pump delivery mode. Infusion stops. | Clear occlusion, press START control. |

| Alarm (continued) | Meaning | Response |
|--|---|--|
| OCCLUDED FLUID SIDE Audio: alarm Visual: continuous scroll | Upstream occlusion sensed while infusing in Pump delivery mode. Infusion stops. | Clear occlusion in fluid side of administration set, press START control. |
| OCCLUDED Audio: alarm Visual: continuous scroll | Occlusion is detected in either fluid or patient side while infusing in Controller delivery mode. Infusion stops. | Clear occlusion and raise the fluid container. Press START control. (If the occlusion recurs, open and close door. Press START control.) |
| PARTIAL OCCLUSION FLUID SIDE Audio: alarm Visual: continuous scroll | Partial upstream occlusion detected while infusing in Pump delivery mode. Infusion stops. | Remove cause of reduced flow in fluid side of administration set, press START control. |
| FLO STOP OPEN/CLOSE DOOR Audio: alarm Visual: continuous scroll | Flo-Stop open (in free flow position) with door open. | Close roller clamp on administration set or close door and resume infusion by pressing START control. |
| KVO COMM CABLE Audio: alarm Visual: continuous scroll | Communication interface cable is disconnected. Infusion continues at KVO rate. | Reconnect communication cable. Press COMPUTER CONTROL/MONITOR control. Restart infusion from host computer. |
| KVO COMM TOUT Audio: alarm Visual: continuous scroll | Communication time-out has occurred. Infusion continues at KVO rate. | Press COMPUTER CONTROL/MONITOR control to change PC-1 operation to MONITOR. |
| KVO Audio: alarm Visual: continuous scroll | A disconnected communications cable has been reconnected. A communications timeout has been corrected. | Press START to restart the infusion. Press COMPUTER CONTROL/MONITOR to restore computer controlled operation. Press COMPUTER CONTROL/MONITOR control. Restart programmed infusion from host computer. |

A **MALFUNCTION** is a signal to alert the operator that a failure has been detected. Immediate action is required. The audio cannot be silenced.

| Malfunction | Meaning | Response |
|--|---|---|
| HELP INTERNAL ERROR Audio: malfunction Visual: continuous scroll and the malfunction code will display in the VTBI display | A software detected malfunction has occurred. Infusion stops. | Press PAUSE/STOP control once to turn off the PC-1. Replace the PC-1 with operable unit. |

NOTE: If Malfunction Code 26 appears, immediately disconnect the AC power cord from the external power source.

| | | |
|---|---|--|
| HELP BATTERY Audio: malfunction Visual: continuous scroll and the malfunction code will display in the VTBI display | Battery shutdown threshold sensed. Infusion stops. | Connect AC power cord to power source. Press PAUSE/STOP control once to turn off the PC-1. Press POWER ON and re-enter the rate and VTBI. Press START to resume the infusion. |
| (WATCHDOG MALFUNCTION) Audio: malfunction Visual: none | A hardware detected malfunction has occurred. Infusion stops. | Press POWER ON control to turn off the PC-1. If audio persists, press POWER ON, then CLEAR/SILENCE. Perform normal power off procedures and replace PC-1 with operable unit. |

ADMINISTRATION SETS/ACCESSORIES

GEMINI™ administration sets available for use with the PC-1:

| | |
|------|--|
| 2200 | GEMINI 20 Vented Primary, 20 drops/mL |
| 2202 | GEMINI 20 Nonvented Primary, 20 drops/mL |
| 2210 | GEMINI 20 Vented Primary with 2 injection sites, 20 drops/mL |
| 2211 | GEMINI 60 Vented Primary with 2 injection sites, 60 drops/mL |
| 2212 | GEMINI 20 Nonvented Primary with 2 injection sites, 20 drops/mL |
| 2213 | GEMINI 60 Nonvented Primary with 2 injection sites, 60 drops/mL |
| 2214 | GEMINI 20 Vented/Nonvented Primary with 2 injection sites, 20 drops/mL |
| 2220 | GEMINI 20 Vented ADD-i-MED Primary with check valve, 20 drops/mL |
| 2222 | GEMINI 20 Nonvented ADD-i-MED Primary with check valve, 20 drops/mL |
| 2230 | GEMINI 20 Vented ADD-i-MED Primary with check valve and 0.22 micron filter, 20 drops/mL |
| 2232 | GEMINI 20 Nonvented ADD-i-MED Primary with check valve and 0.22 micron filter, 20 drops/mL |
| 2240 | GEMINI 20 Vented Primary metered chamber with 3 injection sites, 20 drops/mL |
| 2241 | GEMINI 60 Vented Primary metered chamber with 3 injection sites, 60 drops/mL |
| 2242 | GEMINI 20 Nonvented Primary metered chamber with 3 injection sites, 20 drops/mL |
| 2243 | GEMINI 60 Nonvented Primary metered chamber with 3 injection sites, 60 drops/mL |
| 2260 | GEMINI 20 Vented Primary for Nitroglycerin and Fat Emulsions, 20 drops/mL |
| 2262 | GEMINI 20 Nonvented Primary for Nitroglycerin and Fat Emulsions, 20 drops/mL |
| 2264 | GEMINI 20 Vented Primary for use with Taxol, 20 drops/mL |
| 2277 | GEMINI 12 Nonvented Y-Type for Blood/Solution, 12 drops/mL |
| 2280 | GEMINI Primary Syringe Administration Set |

Accessories available for use with the PC-1:

| | |
|------|--------------------------------------|
| 1303 | Communications Test Plug |
| 1308 | Empty Container Detector (Universal) |
| 2285 | Syringe Holder |

SPECIFICATIONS

(Detailed specifications will be available in the PC-1 Maintenance Manual. IMED reserves the right to change specifications without prior notice.)

| | |
|----------------------|---|
| Operating Principle: | Linear peristalsis |
| Dimensions: | 10.8" x 8.2" x 6.5" (27.5 cm x 20.6 cm x 16.5 cm) |
| Weight: | 11.3 lbs (5.1 kg) |
| Power Requirements: | 90-130 (120 nominal) VAC, 0.5A, 50/60 Hz, 3 wire, single phase |
| Battery Operation: | With a new, fully charged battery, approximately 5 hours at 125 mL/hr before a "HELP BATTERY" |
| Electrical Leakage: | Less than 100 microamps |
| Rate Selections: | 0.1-999 mL/hr |

(Note: Recommended maximum rate in the Controller Mode is 500 mL/hr.)

| | |
|----------------------------------|---|
| MICRO | 0.1-99.9 mL/hr (in 0.1 mL/hr increments) |
| MACRO | 1-999 mL/hr (in 1 mL/hr increments) |
| Volume-to-be-Infused Selections: | 0.1-9999 mL, ALL |
| MICRO | 0.1-999.9 mL (in 0.1 mL increments) |
| MACRO | 1-9999 mL (in 1 mL increments) |
| KVO (Keep Vein Open) Rate: | 1 mL/hr if set rate is 1 mL/hr or above, or actual rate if set at 0.9 mL/hr or below |
| Occlusion Pressure: | |
| · Controller mode | container height |
| Pump mode | 10±2 psi for rates above 30 mL/hr. For rates of 30 mL/hr and below, the occlusion pressure will be less than 10 psi, and is rate-dependent (unless locked into 10 psi for all rates.) |

| | |
|--|--|
| Advisories: | SECONDARY, PRIMARY, INFUSION COMPLETE - KVO, EMPTY CONTAINER - KVO, LOW BATTERY, DIAGNOSTIC, PAUSE, POWER OFF, 10 PSI, LOW FLOW, TOTAL VOL INFUSED, SEC VOL INFUSED, MACRO, MICRO, PANEL LOCKED, VERSATAPER: SETUP, STEP: xx, STEPS: xx, TOTAL VOL: xx, DURATION: xx, VERSATAPER, TIME LEFT: xx, CONTINUE PREVIOUS INFUSION? ↑=YES ↓=NO STEP: xx TIME LEFT: xx:xx VERSATAPER, CONTINUE PREVIOUS INFUSION? ↑=YES ↓=NO, yes, no, AutoTaper: Ramp Time, ramp% xx, AutoTaper Setup, AUTOTAPER: SETUP, SET DURATION, DURATION: xx:xx MAX RATE: xxx RAMP %: xx, AUTOTAPER, TIME LEFT: xx:xx AUTOTAPER, CONTINUE LAST xx:xx OF PREVIOUS INFUSION ↑=YES ↓=NO AUTOTAPER, AutoTaper: Patient, enabled, disabled and VOLUME/TIME ERROR: SET VTBI. |
| Prompts: | SELECT P/C MODE, SET RATE, SET VTBI, and PRESS START. |
| Alarms: | CHECK ECD, CHECK IV SET, CLOSE DOOR, AIR-IN-LINE, OCCLUDED PATIENT SIDE, OCCLUDED FLUID SIDE, OCCLUDED, PARTIAL OCCLUSION FLUID SIDE, FLO-STOP OPEN/CLOSE DOOR, KVO COMM CABLE, KVO COMM TOUT, and KVO. |
| Malfunctions: | HELP INTERNAL ERROR, HELP BATTERY, and (WATCHDOG MALFUNCTION) |
| Air-in-line Detection: | Ultrasonic |
| Secondary (Piggyback): | Dual rate programmable |
| RS-232-C Communications Data Port connector: | Electronic Industry Association (EIA) Standard requires a standard 9-pin sub-miniature male mating connector with a standard screwlock backshell with jack screws for proper mechanical interface. |

CLEANING

IMPORTANT INFORMATION FOR CLEANING YOUR GEMINI INFUSION PUMP

- As with all precision instruments, care and regular maintenance are necessary to ensure safe operation.
- Use only non-staining products recommended for use on plastic materials by their manufacturer, and use them in accordance with their instructions.
- Harsh cleaning materials, improper cleaning procedures, stronger concentrations and/or extended exposures can damage the instrument.
- **DO NOT attempt to sterilize the instrument with Ethylene Oxide gas, heat, steam, radiation, or autoclaving. To do so may damage the pump and void the warranty.**

CLEANING INSTRUCTIONS

CAUTION: Always unplug the power cord from the external AC power source before cleaning. Place the instrument in an upright position to prevent fluids from entering the bottom vents. Do not immerse or stand the instrument in any fluids. Only the external surfaces should be cleaned and disinfected.

Use a solution of mild soapy water, a 10% solution of household bleach, or isopropyl alcohol. Apply the solution with a soft lint free cloth, soft bristle brush, or cotton swab. Clean the Air-In-Line Detector groove, the elements behind the door, and the ECD's groove (if applicable), with cotton tipped swabs saturated with the solution. Disinfect using a non-staining, fungicidal, bacteriocidal, tuberculocidal solution.

Once the contamination has been removed, a cloth wet with fresh water should be used to rinse the entire pump to dilute and remove all residual cleaning/disinfecting solution. Repeat the process completely using another cloth moistened with fresh water. Following the fresh water rinses, thoroughly dry the instrument with a soft, lint-free cloth.

NOTE

Prior to connecting the power cord, ensure that the AC power connector is clean of any residue and dried thoroughly. Check the cord contacts for contamination; if contaminated, remove residue or replace the power cord.

WARRANTY

IMED Corporation (hereinafter referred to as "IMED") warrants that each new IMED product is free from defects in material and workmanship, under normal use and service, for a period of one year from the date of purchase. A defective instrument should be returned to IMED properly packaged, with postage prepaid. IMED will then arrange for repairs or replacement within the terms of this warranty. Loss or damage in return shipment to IMED shall be at the purchaser's risk.

This warranty shall not apply to any IMED product which (1) has been repaired by anyone other than an authorized IMED representative, (2) has been altered in any way so as, in the judgment of IMED, to affect its stability, or reliability, (3) has been subject to misuse, negligence, or accident, (4) has had the serial number altered, effaced or removed, or (5) has been operated otherwise than in accordance with the instructions furnished by IMED.

Installation or use of component parts from sources other than IMED, without the express written consent of IMED, shall void the warranty given herein. In such event, product performance, reliability and liability, suits, claims, or damage arising therefrom shall be the sole responsibility of the user.

This warranty is in lieu of all other warranties, express or implied, and of all other obligations or liabilities on the part of IMED. THERE ARE NO WARRANTIES WHICH EXTEND BEYOND THE DESCRIPTION ON THE FACE HEREOF. IMED DISCLAIMS ANY IMPLIED WARRANTY OF MERCHANTABILITY OR FITNESS FOR A PARTICULAR PURPOSE. IMED disclaims any liability for special, indirect, incidental, consequential, or exemplary damages. IMED neither assumes, nor authorizes any representative or other persons to assume for it, any other liability in connection with the sale of IMED products.

NOTES

NOTES

NOTES

IMED SERVICE CENTER LOCATIONS

San Diego Service Center
10111 Carroll Canyon Road, Bldg. 9
San Diego, CA 92131
(619) 566-9000
(800) 331-4486

Atlanta Service Center
500 Chastain Center Blvd. Suite 535
Kennesaw, GA 30144
(404) 423-1394
(800) 241-4633

Chicago Service Center
1141 N. Main Street
Lombard, IL 60148
(708) 932-4633
(800) 621-4633

Baltimore Service Center
5024 Campbell Blvd. Suite F
Baltimore, MD 21236
(301) 931-7373
(800) 638-4633

Houston Service Center
10530 Rockley Road, Ste 110
Houston, TX 77099 USA
(281) 561-6565
(800) 231-9991

Boston Service Center
15B Constitution Way
Woburn, MA 01801
(617) 938-6660
(800) 457-0027

IMED Canada, Inc.
6675 Millcreek Drive, Unit 4
Mississauga, Ontario
L5N 5M4 CANADA
(416) 821-2212
